

# STRUCTURAL LINKS AND VIBRATION CONTROL

Structural bearings | Expansion joints | Tuned Mass Dampers | Viscous fluid dampers | Services

Structural links and vibration control for bridges .....	3
Technical introduction .....	4
Product range .....	6
Structural bearings .....	8
Elastomeric bearings .....	10
Pot bearings .....	14
Spherical bearings with PTFE and SMS® .....	16
SMS® bearings .....	18
Guide bearings and restraint devices .....	20
Special bearings .....	21
Expansion joints .....	22
Single gap expansion joints .....	24
Reinforced rubber expansion joints .....	26
Finger-type expansion joints .....	28
Special expansion joints .....	29
Vibration control .....	30
Tuned Mass Dampers .....	32
Viscous fluid dampers .....	34
Seismic devices .....	36
Viscous fluid dampers .....	38
Services .....	40
Quality .....	42



## Structural links and vibration control for bridges

SCHREIBER is a specialised company. As a global specialist, SCHREIBER caters to the requirements of customers in civil and plant engineering, in the railway sector and in many other industries.

Solutions for the minimisation of unwanted vibration in civil engineering projects and industrial plants, seismic protection and products which protect buildings and structures against traffic-induced vibration are just a few examples from the SCHREIBER product and service portfolio.

SCHREIBER places great value on finding the optimum solution for each specific application. To achieve this, SCHREIBER is a one-stop provider uniting all state-of-the-art manufacturing technologies and engineering methods in order to offer its customers the very best products and services.

The merger with the LISEGA Group in 2015 expanded the product range to include a series of products and solutions for the infrastructure and bridge construction sectors. SCHREIBER has more than 40 years' experience in the calculation, configuration and production of bridge bearings and expansion joints for bridges all over the world and is an important global player in the civil engineering and infrastructure industries.

With the combined know-how of LISEGA and SCHREIBER, we offer our customers in the infrastructure construction sector a unique range of products and services.

# Technical introduction

Although at first glance, bridges may seem solid and motionless, they are in fact flexible structures. They move in response to various phenomena such as temperature expansion, traffic load, creeping or shrinkage of concrete, wind or earthquakes. The forces induced by this movement increase the inherent and live loads of the bridge.

Every bridge needs to be designed in such a way that it can move within the predefined limits without the sum of the forces applied overstressing the structure. Structural bearings, expansion joints, mass dampers and viscous fluid dampers are products which help to meet these design requirements.

## Expansion joints



The basic function of expansion joints is to allow a smooth flow of traffic while at the same time allowing movement of the bridge as the result of thermal expansion and the creeping or shrinking of concrete or of composite structures.

Various types of expansion joint are available, depending on the roadway, the overall bridge design and the expected movements in longitudinal and transverse direction. SCHREIBER offers a wide range of expansion joints, including single gap expansion joints, finger-type expansion joints and reinforced elastomer expansion joints.

## Viscous fluid dampers



Viscous fluid dampers are used in bridge construction to counteract unusual movements, for example caused by wind or earthquakes.

## Structural bearings

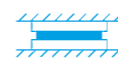

Bridge bearings are designed to transfer load, displacement and rotational forces from the bridge superstructure (roadway) to the substructure (piers, abutments and foundations) within the limits of the design requirements. As defined by European Standard EN 1337 "In civil engineering, bearings are elements allowing rotation between two members of a structure and transmitting the loads defined in the relevant requirements as well as preventing

displacements (fixed bearings), allowing displacements in only one direction (guided bearings) or in all directions of a plane (free bearings) as required." To meet these requirements, SCHREIBER has developed a broad range of elastomeric bearings, pot bearings, spherical bearings, guide bearings and restraint devices.

## Mass dampers

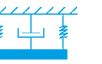

Tuned Mass Dampers (TMDs) are devices designed to minimise unwanted vibrations induced by traffic loads and wind. TMDs can significantly reduce dynamic loads, allowing simplification of the overall structure. As a result, bridges can be designed with a more slender structure and more cost-effectively.

# SCHREIBER product range

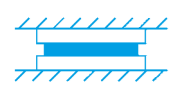

Structural bearings



Expansion joints

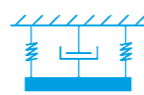

Mass dampers



Viscous fluid dampers



Services

SCHREIBER has developed a wide range of structural bearings, expansion joints, Tuned Mass Dampers and viscous fluid devices for the construction and plant engineering sectors. All typical design requirements can be met with these products. The technical experts at SCHREIBER are available to help define the right product for each specific application.

## Structural bearings

Type	Design		Max. vertical load V [MN]	Max. horizontal load H [MN]	Max. horizontal movement	Max. rotation [rad]	Service life [years]
Standard elastomeric bearings	Free, movable in all horizontal directions 5 different versions depending on anchoring system	» S-EB	15	5 % of V	Depending on rubber height Max. shear deformation $\tan \gamma = 1.0$	0.015 Value depends on rubber height	25
Guide bearings, restraint devices	Fixed, with restriction in both horizontal directions Movable, with restriction in one horizontal direction	» S-RBF » S-RBU	15	Up to 50 % of V in the restrained direction 5 % of V in the non-restrained direction	Depending on rubber height Max. shear deformation $\tan \gamma = 1.0$	0.015 Value depends on rubber height	25
Elastomeric sliding bearings	Movable, with restriction in one horizontal direction Free, movable in all horizontal directions	» S-SBU » S-SBM	15	Up to 50 % of V in the restrained direction	No design limits	0.015 Value depends on rubber height	25
Pot bearings	Fixed, with restriction in both horizontal directions Movable, with restriction in one horizontal direction Free, movable in all horizontal directions	» S-P » S-PU » S-PM	50	Up to 70 % of V	No design limits	0.02	50
Spherical bearings	Fixed, with restriction in both horizontal directions Movable, with restriction in one horizontal direction Free, movable in all horizontal directions	» S-S » S-SU » S-SM	50	Up to 100 % of V	No design limits	0.15 and more	50
Spherical bearings SMS®	Fixed, with restriction in both horizontal directions Movable, with restriction in one horizontal direction Free, movable in all horizontal directions	» SMS-S » SMS-SU » SMS-SM	100	No design limits	No horizontal movements No design limits	0.15 and more	50

## Expansion joints

Type		Movements [mm]		Vertical	Noise reduction	Service life [years]
		Longitudinal	Transverse			
Single gap expansion joints	» S-JS	80	120	10	No	50
Single gap expansion joints with noise reduction	» S-JSR	120	120	10	Yes	50
Finger-type expansion joints	» S-F	Up to 1,600	-	10	Yes	50
Reinforced rubber expansion joint	» VS-Flex	Up to 320	Up to 320	20	No	25

## Viscous fluid dampers

Type		Behaviour with slow movements (thermal movements, creep, shrinkage)	Behaviour with dynamic loads (vehicle braking, wind, earthquakes)	Max. axial load [MN]	Max. stroke [mm]	Service life [years]
Viscous fluid dampers	» S-VD	Allow movement with negligible reaction force	Reduce dynamic force by damping energy (by up to 75 %)	10	1,000	50
Lock-up devices (STUs)	» S-STU	Allow movement with negligible reaction force	Transmit dynamic force as a rigid link	20	1,000	50

The table below provides a brief overview of the SCHREIBER product range. It is intended to serve as a basic guideline for selecting the right product type from the wide range available. Further technical details on the products and their specific applications can be found on the following pages.

## Tuned Mass Dampers

Type	Design	Service life [years]
TMD	Special products which reduce unwanted vibrations and structural noise caused by wind, earthquakes or traffic loads Various configurations are available for horizontal and/or vertical directions Can be adapted to all types of structure	50

## Services: Engineering services offered



Structural engineering

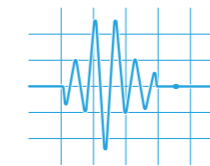

Vibration measurement

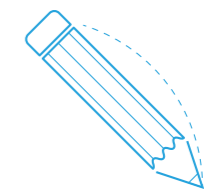

Special product design

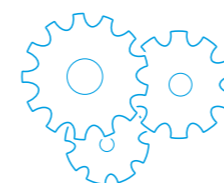

Installation

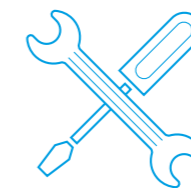

Repair and maintenance

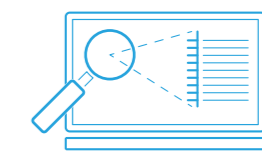

Monitoring systems



**STRUCTURAL BEARINGS**

# SCHREIBER elastomeric bearings

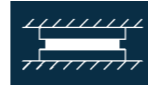

SCHREIBER elastomeric bearings are suitable for connecting different sections of a structure while transferring loads in vertical and horizontal direction and permitting both horizontal displacements and rotations. Thanks to their modular design and a wide selection anchoring options, they can be used in any structure.

## Design

Generally, elastomeric bearings consist of a rubber (elastomeric) block reinforced with internal steel plates. The steel plates increase the vertical rigidity of the elastomer and thus its load-bearing capacity.

Typical permissible vertical loads for SCHREIBER elastomeric bearings are up to 15 MN. The typical permissible horizontal loads lie between 5 % and 10 % of the vertical load. For higher loads, special versions can be used in accordance with standardised design procedures.

SCHREIBER elastomeric bearings can be divided into three groups based on the requirements in horizontal direction:

### ■ Standard elastomeric bearings – Type S-EB

Standard elastomeric bearings of type S-EB consist of a reinforced elastomeric block which can be equipped with external steel plates in order to improve the anchoring to the surrounding structure.

The load transfer and movement characteristics of these bearings in horizontal direction are defined by the elastomer resistance and the deformation capacity.

### ■ Guide bearings, restraint devices – Type S-RB

Guided elastomeric bearings of type S-RB consist of an elastomeric block, upper and lower anchor plates and a steel frame preventing horizontal movement in the respective direction.

In the case of bearings of Type S-RBF, a restraint device controls the horizontal load transfer. In the case of bearings of Type S-RBU, the unidirectional horizontal forces are transferred in the respective direction via a restraint device.



Elastomeric bearing  
Type S-EB4

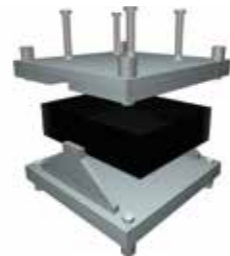

Guided elastomeric bearing  
Type S-RBF

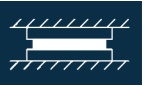

### ■ Elastomeric sliding bearing – Type S-S

The design of the sliding elastomeric bearings of Type S-SB is similar to that of the standard elastomeric bearings. The only difference is that these bearings are equipped with an external sliding element. The sliding element itself comprises a stainless steel plate and a PTFE sheet. With corresponding lubrication, this element has a very low friction coefficient.

As horizontal displacements are made possible by the sliding element – and not by the deformation of the elastomeric block – sliding elastomeric bearings allow significantly greater horizontal displacements than the standard or guided elastomeric bearings.

Bearings of Type S-SBM allow displacement in both horizontal directions. Bearings of Type S-SBU with additional steel restraints allow displacement in one horizontal direction only.

## Configuration of elastomeric bearings

SCHREIBER elastomeric bearings are designed in accordance with EN 1337 and bear the CE Mark. If required, they can also be designed and manufactured in compliance with other international standards such as AASHTO, BS or DIN.

The SCHREIBER engineers are available to support you in selecting the right bearing type and the best solution for your application. The following data are required for the configuration of elastomeric bearings:

- Load cases, i.e. vertical and horizontal loads, horizontal displacements and rotations corresponding to minimum and maximum vertical load and to maximum horizontal load at the ultimate limit state (ULS)
- General description of the structural, spatial or anchoring requirements



Free sliding elastomeric bearing  
Type S-SBM





Unidirectional sliding  
elastomeric bearing  
Type S-SBU

## STRUCTURAL BEARINGS

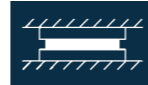
Elastomeric bearings product range

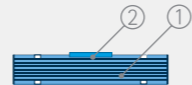
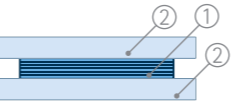
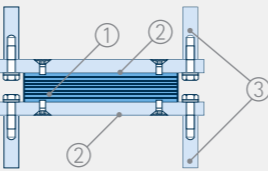

### Standard elastomeric bearings

Type	Design
S-EB1	Reinforced elastomeric block with no additional anchors to the structure 
S-EB2	Reinforced elastomeric block with external steel plates to allow connection to the structure 
S-EB3	Reinforced elastomeric block with external steel plates, with or without anchors 
S-EB4	Reinforced elastomeric block with external plates vulcanised to the elastomer and connected to anchoring plates 
S-EB5	Reinforced elastomeric block with external checker steel plates vulcanised to the elastomer – these plates provide higher friction and thus allow a higher horizontal load transfer 

### Guide bearings, restraint devices

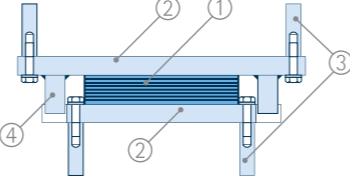
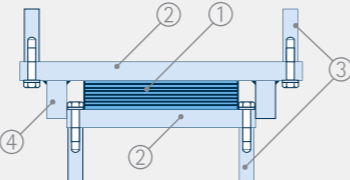
Type	Design
S-RBF	Elastomeric bearing as complete frame restraint, suitable for transferring horizontal forces in all directions 
S-RBU	Elastomeric bearing as one-sided restraint, suitable for transferring horizontal forces in one direction 

### Elastomeric sliding bearing

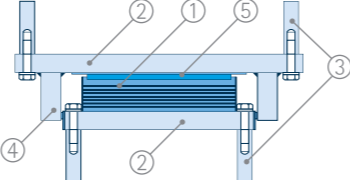
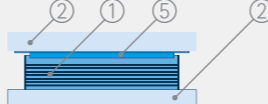
Type	Design
S-SBU	Elastomeric bearing with a guided sliding element which allows large displacements in one direction 
S-SBM	Elastomeric bearing with a sliding element which allows large displacements in all horizontal directions 



Guided elastomeric bearing, Type S-RBU, installed



Final assembly of elastomeric bearings in the SCHREIBER plant

- ① Reinforced elastomeric block
- ② External steel plates
- ③ Anchors
- ④ Steel guides
- ⑤ Sliding element

An overview of the typical loads, permissible displacements and rotations can be found on page 6.

# Pot bearings



Pot bearings are designed to transfer the loads from, for example, the roadway of a bridge to its piers and foundations.

With regard to horizontal displacement, pot bearings can act as a restraint in one (uni-directional) or two directions (fixed), or they can allow free movement in all directions (free sliding). They also allow rotation around all axes.

### Design

Pot bearings consist of a round steel baseplate (pot) with an inserted elastomeric disc. A steel cover is positioned above the elastomeric disc, ensuring that vertical loads are transferred from the cover to the baseplate through the disc. A special gasket is installed at the edge of the disc to prevent the elastomeric disc being forced out of the baseplate when compressed.

When compressed, the elastomer acts as an incompressible fluid preventing vertical deflection, but due to its deformability, it allows rotation around all axes.

Horizontal loads are transferred through the steel-steel contact between the steel cover and the baseplate. This solution allows the transfer of extremely high horizontal loads.

Movable bearings (unidirectional and free sliding) are equipped with a sliding plate above the steel cover. The sliding plate consists of a steel plate and a stainless steel sheet. This steel sheet is in contact with a PTFE sheet covering the upper side of the cover. Pot bearings can be equipped with different anchoring systems depending on the design requirements. The anchors are installed directly on the baseplate, on the steel cover (in fixed bearings) or on the sliding plate (in unidirectional and free sliding bearings).

In the case of unidirectional pot bearings, a guide allows movement in one direction and restrains perpendicular movement while transferring the corresponding loads.

External anchor plates can be supplied to facilitate installation and replacement. In this case, the anchors are installed on the anchor plates themselves.



Fixed pot bearing, Type S-P, with anchor plates



Unidirectional pot bearing Type S-PU



Free sliding pot bearing Type S-PM

- ① Cover
- ② Elastomeric disc
- ③ Pot
- ④ Guide
- ⑤ Sliding plate
- ⑥ Sliding surface (PTFE + stainless steel)
- ⑦ Gasket

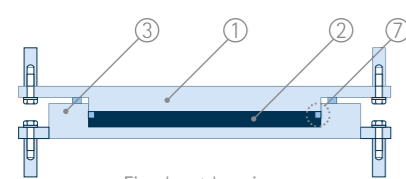

Fixed pot bearing Type S-P

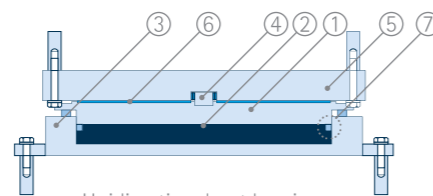

Unidirectional pot bearing Type S-PU

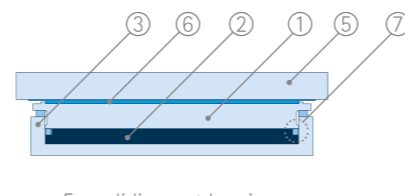

Free sliding pot bearing Type S-PM



Assembly of free sliding pot bearings



Final quality inspection of the free sliding pot bearing

### Configuration of pot bearings

SCHREIBER pot bearings are designed in accordance with EN 1337 and bear the CE Mark. If required, they can also be designed and manufactured in compliance with other international standards such as AASHTO, BS or DIN.

The SCHREIBER engineers are available to help you select the right bearing type and the best solution.

The following data are required for configuration of a pot bearing:

- Load cases, i.e. vertical and horizontal loads, horizontal displacements and rotations corresponding to minimum and maximum vertical load and to maximum horizontal load at the ultimate limit state (ULS)
- General description of the structure, geometrical limitations such as installation height and anchoring requirements



Pot bearings after installation

Type	Design	Max. vertical load V [MN]	Max. horizontal load H [MN]	Max. horizontal movement	Max. rotation [rad]	Service life [years]
Pot bearings	Fixed, with restriction in both horizontal directions	» S-P				
	Movable, with restriction in one horizontal direction	» S-PU	50	Up to 70 % of V	No design limits	0.02
	Free, movable in all horizontal directions	» S-PM				



# Spherical bearings



SCHREIBER spherical bearings represent the state of the art in the structural bearings range. They are suitable for transferring extremely high loads.

SCHREIBER spherical bearings can restrain or allow movements in horizontal directions and, thanks to the internal spherical hinge, allow large rotations around every axis.

## Design

Spherical bearings comprise a sliding plate, a hard chromium plated spherical cap and a convex steel baseplate. Two circular PTFE sheets are inserted in recesses, one on the top of the convex baseplate and one on the top of the spherical cap. The PTFE sheet inserted in the baseplate is in contact with the lower hard chromium surface of the cap, while the sheet inserted in the cap is in contact with a stainless steel sheet that is welded or bolted to the top plate.

Due to low friction between the PTFE sheets and their stainless steel or hard chromium plated counter-surfaces, the top plate, the baseplate and the cap can slide against each other, thus allowing displacement and rotation. The surface of the stainless steel has a polished finish.

Vertical loads are transferred from the top via the PTFE surfaces and the spherical cap to the baseplate. Horizontal loads are transferred through the steel-steel contact between sliding plate and baseplate, without any load transfer via the spherical cap. This makes spherical bearings particularly suitable for transferring very high horizontal loads.

Movable bearings - unidirectional and free sliding - are accommodated by different designs of the sliding plate. In guide bearings, a guiding element limits displacement between the baseplate and the spherical cap.

The anchoring of the spherical bearings can be configured to customer specifications. Typically, anchors are installed directly on the sliding plate and the baseplate. Anchoring via additional anchor plates is also possible.

## Configuration of the spherical bearings

SCHREIBER spherical bearings are designed in accordance with EN 1337 and bear the CE Mark. If required, they can also be designed and manufactured in compliance with other international standards such as AASHTO, BS or DIN.



Fixed spherical bearing, Type S-S



Unidirectional spherical bearing Type S-SU



Free sliding spherical bearing Type S-SM

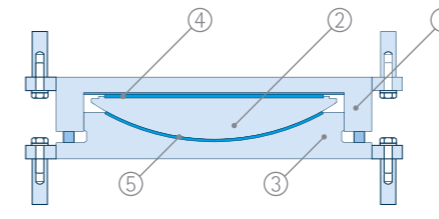

Fixed spherical bearing, Type S-S

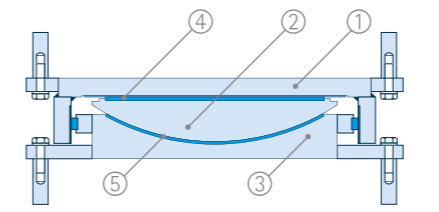

Unidirectional guided spherical bearing Type S-SU

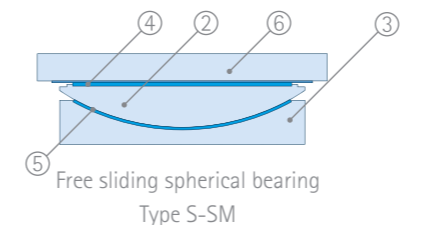

Free sliding spherical bearing Type S-SM

- ① Bearing plate
- ② Spherical cap
- ③ Cap fixture
- ④ Sliding surface (PTFE + stainless steel)
- ⑤ Sliding surface (PTFE + hard chrome)
- ⑥ Sliding plate

The SCHREIBER engineers are available to help you select the right bearing type and the best solution. The following data are required for configuration of a spherical bearing:

- Load cases, i.e. vertical and horizontal loads, horizontal displacements and rotations corresponding to minimum and maximum vertical load and to maximum horizontal load at the ultimate limit state (ULS)
- General description of the structural, spatial or anchoring requirements



Type	Design		Max. vertical load V [MN]	Max. horizontal load H [MN]	Max. horizontal movement	Max. rotation [rad]	Service life [years]
Spherical bearings	Fixed, with restriction in both horizontal directions	» S-S					
	Movable, with restriction in one horizontal direction	» S-SU	No design limits	Up to 100 % of V	No design limits	0.15 and more	50
	Free, movable in all horizontal directions	» S-SM					

# STRUCTURAL BEARINGS

## SMS® bearings

### Characteristics of SMS® bearings

Contact pressure and temperature are decisive for the friction coefficient of slide bearings. This coefficient plays a central role in the dimensioning of the bearings and for the forces to be transferred. The lower the coefficient, the more compact the bearing.

Friction  $\mu$  at moderate temperature  $-5^\circ\text{C} < T$

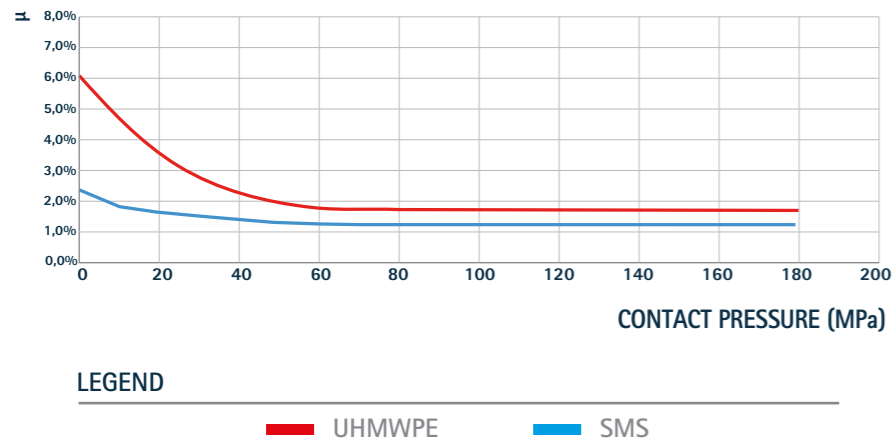

- 50 km slide distance
- Low friction
- Long service life



Cap fixture with sliding material SMS®

The load-bearing capacity of slide bearings depends on their characteristic stress level. Here, SMS® exceeds PTFE by about 100 %. At higher temperatures, the stress level is still greater than that of other products. This makes bearings with SMS® ideal for areas with extreme requirements.

Convincing compressive strength

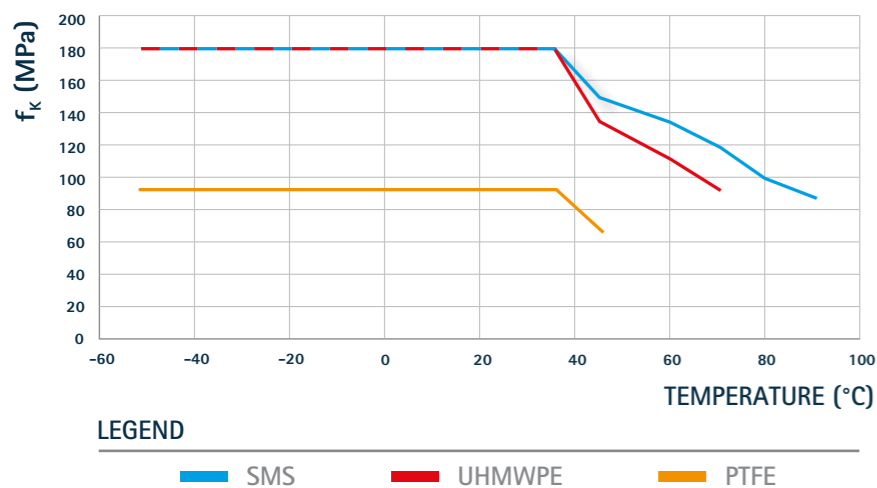

### Aim

SMS® is a special bearing material used for slide bearings in a wide range of applications, especially for spherical and pot bearings.

### Description

SMS® is a modified polytetrafluorethylene (PTFE). Like PTFE, SMS® offers remarkable slide characteristics thanks to its very low friction coefficient. But in addition, SMS® has significantly higher load capacities. All this means lower operating costs for bearings, in particular spherical and pot bearings. And SMS® retains these excellent material characteristics even at extremely high or extremely low temperatures.

### Advantages

- Longer service life:** In the long term, SMS® is up to five times more resistant to wear than PTFE, giving it an extended service life.
- Less friction:** At moderate temperatures, SMS® has a lower friction coefficient than PTFE and UHMWPE.
- Wide temperature range:** SMS® can be used at temperatures between  $-50^\circ\text{C}$  and  $+90^\circ\text{C}$ . PTFE exhibits lower strength at  $48^\circ\text{C}$ , UHMWPE at  $70^\circ\text{C}$ .
- Higher pressure resistance:** SMS® allows a contact pressure twice as high as that of PTFE.

- Longer service life
- Economical spherical bearings
- Optimised installation for spherical bearings

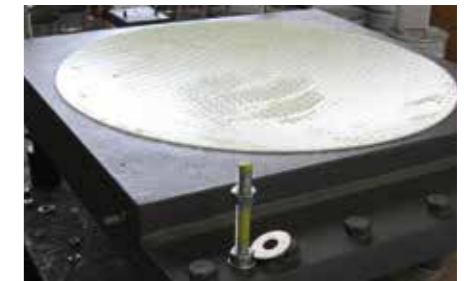

SCHREIBER SMS® cap fixture



SCHREIBER SMS® bearing material

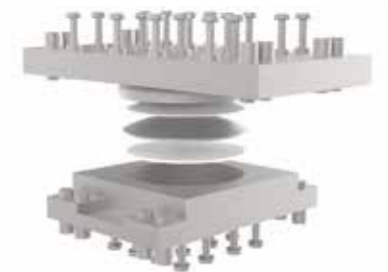

SCHREIBER SMS® fixed spherical bearing

### SMS® and certifications

Bearings with SMS® were subjected to a European Technical Assessment (ETA) under reference number ETA-20/0320. All slide bearings bear the CE Mark. Certification was awarded following final tests in accordance with EN 1337. In a long-term slide-distance test, SMS® was tested over 50,000 m. This corresponds to a service life of 50 years.

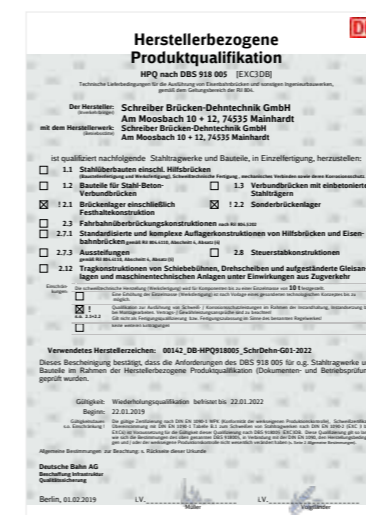

## STRUCTURAL BEARINGS

# Guide bearings and restraint devices



Restraint devices are structural components designed to transfer horizontal loads and to accommodate rotations. They do not transfer vertical loads.

In general, pot bearings or spherical bearings are suitable for transferring both vertical and horizontal loads. However, the design of these bearings is no longer efficient if the horizontal forces acting in the structure are significantly higher than the vertical forces. In such cases, restraint devices offer a good solution, as they allow the transfer of high horizontal loads but require little space.

For this reason, they are normally used in combination with free sliding bearings, thus splitting the transfer of horizontal and vertical loads.

### Design

There are two basic types of restraint devices. Depending on their configuration, they transfer loads in only one or in two horizontal directions:

- Fixed restraint devices if they transfer forces in all directions
- Movable restraint devices or guides, if they transfer forces in one axis and allow movement in the other axis.

In general, restraint devices consist of two steel elements forming a male-female joint and transferring the forces within the structure through suitable anchors. The male-female joint must be designed to allow the required rotations.

The detailed design of restraint devices may vary considerably, depending on the magnitude of the forces which are active, the required movements and rotations as well as the available space.

### Configuration of the restraint device

SCHREIBER restraints are designed in accordance with EN 1337 and bear the CE Mark. If required, they can also be designed and manufactured in compliance with other international standards such as AASHTO, BS or DIN.

The SCHREIBER engineers are available to help you select a restraint device and the best solution for your application. The following data are required for configuration of a restraint device:

- Maximum horizontal load in the ultimate limit state (ULS) and corresponding horizontal displacements and rotations
- General description of the structural, spatial or anchoring requirements



Installation of a fixed restraint device



Bearing position indicator

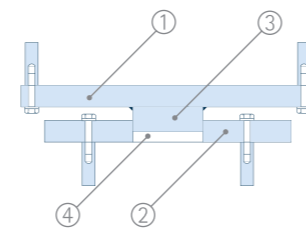

Fixed restraint device  
Type S-K

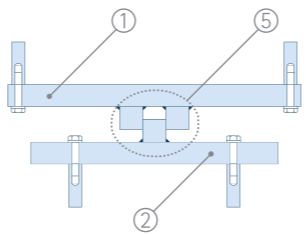

Movable restraint device  
Type S-KU

- ① Top bearing plate
- ② Bottom bearing plate
- ③ Pin
- ④ Pin housing
- ⑤ Guide

Type	Design		Max. vertical load V [MN]	Max. horizontal load H [MN]	Max. horizontal movement	Max. rotation [rad]	Service life [years]
Shear key	Fixed, with restriction in both horizontal directions	» S-K	No vertical load permitted	No design limits	No horizontal movements	0.15 and more	50
	Movable, with restriction in one horizontal direction	» S-KU	No vertical load permitted	No design limits	No design limits	0.15 and more	50

## STRUCTURAL BEARINGS

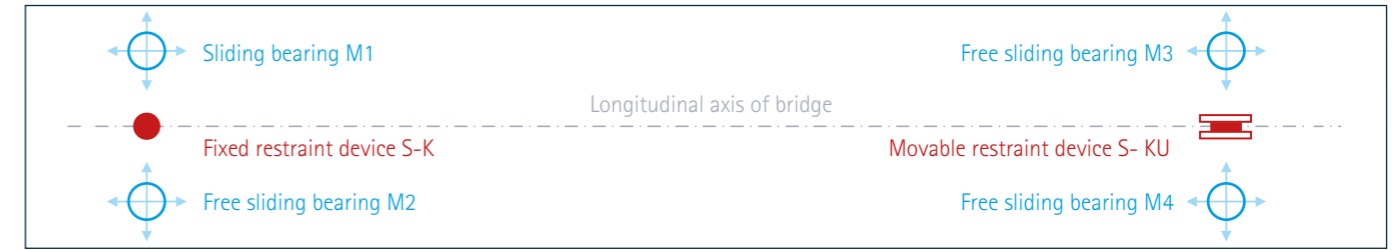

Restraint device - typical setup with structural bearings

# Special bearings

Elastomeric, pot and spherical bearings are the most common solutions used in bridge construction to form structural links between abutments/piers and the bridge deck.

In specific cases, however, special bearings of different designs may be required. In particular, they are often indispensable when carrying out bridge maintenance, when it is necessary to replace existing special components without changing the layout of the structure.

With its long-standing experience, SCHREIBER is able to design and supply a wide range of special bearings such as:

- **Roller bearings**  
These bearings consist of one or more cylindrical rollers positioned between an upper and a lower steel plate. The vertical loads are transferred through a linear contact between rollers and steel plates, while the horizontal movement occurs through the rolling of the cylindrical component.
- **Rocker bearings**  
In rocker bearings, the vertical loads are transferred via a linear contact (linear rocker bearings) or localised contact (point rocker bearings) between a curved steel plate and a rocker plate. Rocker bearings also allow rotations in one direction (line rocker bearings) or in every direction (point rocker bearings) through the rotation of the curved component on the rocker plate.
- **Customised solutions**  
There are many other applications where customised solutions with very special functionality and layouts may be necessary. SCHREIBER's technical department provides assistance and solutions in every phase of a bridge bearing project, from design to construction right through to installation and maintenance.

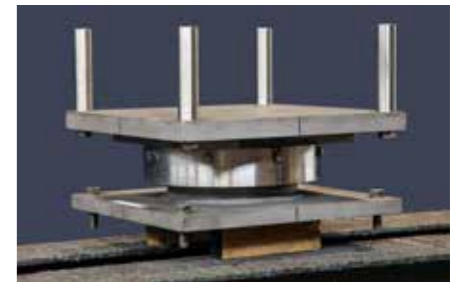

Spherical tensile-compression bearing made from VA



Roller bearing made from VA

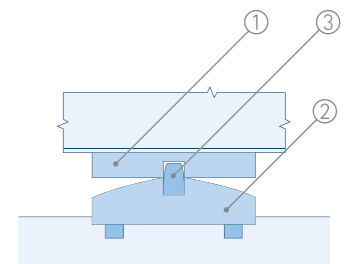

Rocker bearing

- ① Rocker plate
- ② Radius plate
- ③ Guide bolt

Special bearings can be designed and manufactured in accordance with EN 1337. If required, they can also be supplied in compliance with other international standards such as AASHTO, BS or DIN.

## EXPANSION JOINTS



# EXPANSION JOINTS

## Single gap expansion joints

The single gap expansion joint of Type S-JS is designed to allow longitudinal movement of 100 mm and transverse movement of 120 mm. Rotational and vertical movements and rotations can also be accommodated.

### Design Type S-JS

The S-JS expansion joint comprises two symmetrical steel profiles. These profiles are connected by an elastomeric profile covering the bridge gap and thus ensuring that the expansion joint is watertight. The water tightness of the SCHREIBER S-JS expansion joints has been tested in the Stuttgart MPA laboratory in accordance with German standard TL/TP FÜ (03/05).

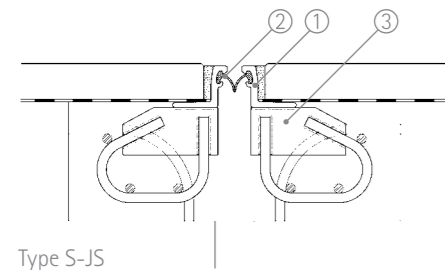

- ① Steel profile
- ② Watertight elastomeric profile
- ③ Anchor

Type S-JS

The elastomeric compound was developed to resist oil, grease, salt and other aggressive media, thus guaranteeing a long service life for the joint.

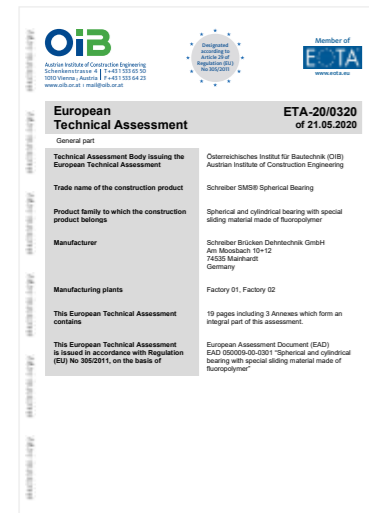

Single gap expansion joint



VA walkway



Flush-mounted steel profile in the walkway



### Type S-JSR with noise reduction

Single gap expansion joints can be equipped with noise reduction profiles in order to reduce noise emissions.

The S-JSR consists of two steel profiles, similar to those of the standard S-JS, onto which two special wave-shaped plates are bolted. This significantly reduces the noise when a vehicle drives over the expansion joint.

The wave-shaped noise protection elements increase the longitudinal movement to 120 mm.

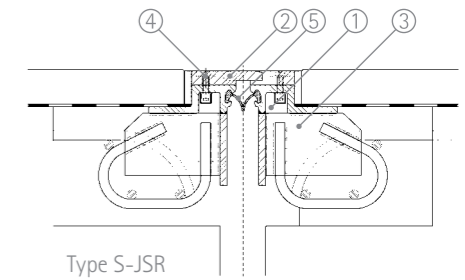

Type S-JSR

- ① Claw profile
- ② Noise reduction element
- ③ Anchor
- ④ Bolted connection
- ⑤ Watertight elastomeric profile

### Configuration of a single gap expansion joint

The SCHREIBER engineers are available to help you select the right expansion joint type and the best solution.

The following data are required for the configuration of a single gap expansion joint:

- Maximum longitudinal and transverse movement (mm)
- Gap width (mm)
- Road cross-section
- Special requirements such as layout of walkways, customer requirements, surface treatment, noise reduction requirements

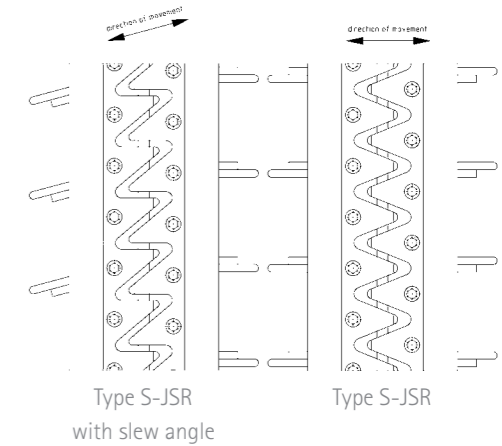

Type S-JSR with slew angle

Type		Movements [mm]		Vertical	Noise reduction	Service life [years]
		Longitudinal	Transverse			
Single gap expansion joints	» S-JS	100	120	10	No	50
Single gap expansion joints with noise reduction	» S-JSR	120	120	10	Yes	50

## S-JSR expansion joints



## Single gap expansion joint with noise reduction installed

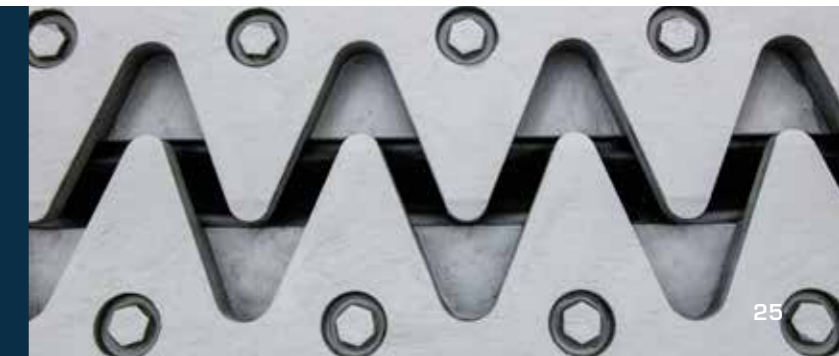

## Reinforced expansion mats

SCHREIBER reinforced expansion mats of the Type S-Flex are designed to compensate for longitudinal and transverse movements from 50 mm to 320 mm. Vertical movements of up to 20 mm and rotations can also be absorbed.

S-Flex expansion joints are a very compact and cost effective solution, particularly suitable for replacements due to the low space requirement and the simple installation concept.

### Design

S-Flex expansion joints consist of elastomers reinforced by vulcanised steel profiles. The deformation of the elastomer compensates for the movements of the bridge.

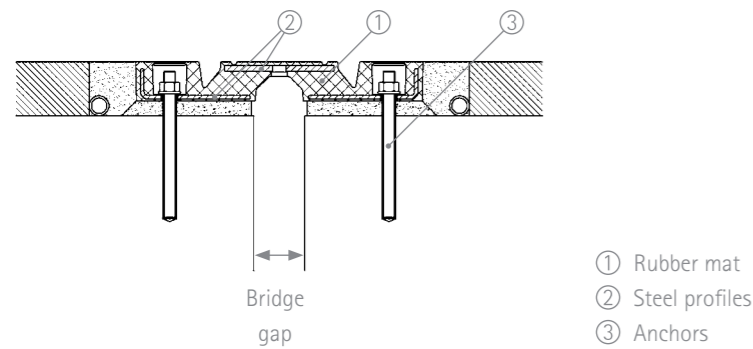

The rubber compound was specially developed to resist oil, grease, salt and other aggressive media over an extended period.

SCHREIBER S-Flex expansion joints are manufactured in modules with a length of two metres. They are installed side-by-side to cover the complete cross-section of a bridge.

Each rubber module can be connected to the next via a male-female joint. This feature mean that if a module needs to be replaced, it is only necessary to replace the damaged module instead of the entire expansion joint. An additional advantage is that it is only necessary to close a section of the bridge in order to replace a module, allowing quicker maintenance and above all a continuous traffic flow.

Various types of elastomer expansion joint are available depending on the width of the gap and the expected movements.

The anchors are designed to withstand heavy traffic loads, including horizontal forces induced by braking vehicles.



### S-Flex product range

A special surface layout of the joints reduces noise emissions due to vehicles driving over the expansion joints and preserves good tyre adhesion. SCHREIBER S-Flex expansion joints are waterproof. Water tightness is provided by a rubber seal which is attached to the edges of the gap. The shape of the seal allows longitudinal and transverse movement.

Reinforced rubber expansion joints can be supplied with aluminium or stainless steel covers for the walkway gaps.

### Configuration of a reinforced rubber expansion joint

The SCHREIBER engineers are available to help you select the right expansion joint type and the best solution. The following data are required in order to design a reinforced rubber expansion joint:

- Maximum longitudinal and transverse movement (mm)
- Gap width (mm)
- Road cross-section
- Special requirements such as walkway layout or specifications



S-Flex installed



S-Flex in operation



S-Flex 50

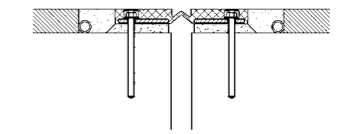

S-Flex 80

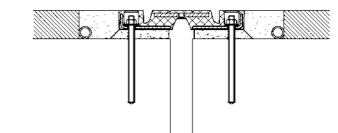

S-Flex 120

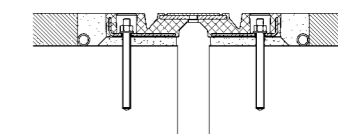

S-Flex 160

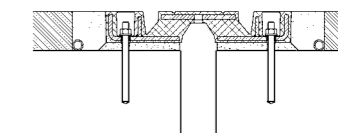

S-Flex 200

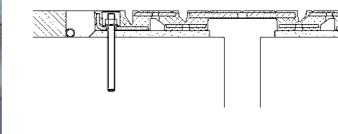

S-Flex 250

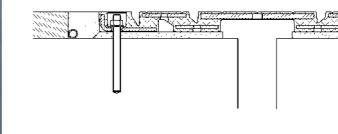

S-Flex 320

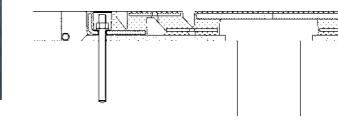

Reinforced rubber expansion joints Type	Movements [mm]		Bridge gap [mm]	Service life [years]
	Longitudinal and transverse	Vertical		
S-Flex 50	50	20	45	20
S-Flex 80	80	20	50	20
S-Flex 120	120	20	70	20
S-Flex 160	160	20	90	20
S-Flex 200	200	20	110	20
S-Flex 250	250	20	140	20
S-Flex 320	320	20	220	20

## EXPANSION JOINTS

# Finger-type expansion joints



SCHREIBER finger-type expansion joints of Type S-F are designed to cover longitudinal movements of the bridge deck from 50mm to 1,600 mm. Their robust design allows high traffic loads and ensures extreme resistance to material fatigue, guaranteeing a long service life.

### Design

SCHREIBER finger-type expansion joints comprise two symmetrical finger-shaped plates bolted to two base profiles.

A special design allows the joint to absorb transverse movements. To provide this feature, one of the two finger-shaped plates must be disconnected from the anchoring profile in order to allow the joint to move. This simple concept means there is no limitation to the transverse movement.

In order to connect the joint to the bridge, anchors welded on the steel profiles are cast into the concrete of the roadway. This ensures an extremely robust connection and excellent resistance to fatigue. SCHREIBER finger-type expansion joints are waterproof. Water tightness is provided by a rubber seal which is attached to the edges of the gap. The shape of the seal allows longitudinal and transverse movement.

As in the case of the single gap expansion joints with noise reduction of Type S-JSR, wheels crossing the joint always touch at least one of the finger-shaped plates.

Due to this geometry of the finger-type expansion joints, noise emissions when vehicles drive over the joints are very low. Finger-type expansion joints can be supplied with aluminium or stainless steel covers for the walkway gaps.

### Configuration of a finger-type expansion joint

The SCHREIBER engineers are available to help you select the right expansion joint type and the best solution. The following data are required for the configuration of a finger-type expansion joint:

- Maximum longitudinal and transverse movement (mm)
- Gap width (mm)
- Road cross-section
- Special requirements such as layout of walkways, specifications or surface treatment



Finger-type expansion joint with stainless steel walkway



Finger-type expansion joint in operation

Type		Movements [mm]		Vertical	Noise reduction	Service life [years]
		Longitudinal	Transverse			
Finger-type expansion joints	» S-F	100 to 1,200	No design limits	10	Yes	50

## EXPANSION JOINTS

# Special expansion joints



Based on its long-standing experience, SCHREIBER is able to design and manufacture a wide range of special expansion joints which are used, for example, during bridge maintenance:

### ■ Roller shutter joints

These extremely robust expansion joints comprise a set of steel plates which can roll along a curved support (roller shutter) – they allow very large longitudinal movements of up to 1000 mm and more with a very reliable and safe design. SCHREIBER has been designing and replacing these particular products for more than 30 years.

### ■ Expansion joints with multiple steel profiles

These joints are suitable for large movements up to 400 mm and more – they consist of a set of steel profiles and are supported by a kinematic mechanism installed in the joint gap.

### ■ Customised solutions

There are many other applications where customised solutions with very special functionality and layouts may be necessary – SCHREIBER's technical department provides assistance and solutions in every phase of a bridge project, from design and construction right through to installation and maintenance.



Handling and positioning of expansion joints with multiple steel profiles



Surface detail of roller shutter joint



Roller shutter joint during installation

**VIBRATION CONTROL**





# Tuned Mass Dampers (TMDs)



Bridges can be affected by unwanted vibrations with various causes, for example wind, traffic or earthquakes. If not properly controlled, these vibrations can lead to high stress, resulting in premature fatigue of the bridges' structures. In the case of footbridges, even pedestrians can cause the bridge to oscillate, creating discomfort and structural risk.

A particularly dangerous situation arises if the excitation frequency is the same as or close to the natural frequencies of the bridge. In this case the bridge begins to resonate, resulting in oscillation beyond an acceptable, i.e. safe, level. SCHREIBER Tuned Mass Dampers (TMDs) are a very efficient solution for controlling unwanted vibrations and keeping oscillations within acceptable limits.

## Design

The Tuned Mass Damper is a device consisting of a mass, a spring and a damping element, which, when installed on a bridge, reduces its dynamic response. In fact, a TMD can efficiently absorb the energy of the bridge's vibrations. For efficient absorption, the TMD must be tuned to the main natural frequency of the bridge.

One of the advantages of TMDs is that they do not require an external abutment. They can be installed directly on the bridge. This makes it very simple to install TMDs when building new bridges or retrofitting existing ones. SCHREIBER designed its first TMD, through its partner WOELFEL, for the Erlach footbridge, Germany, in 1971.

TMDs from SCHREIBER are equipped with a damping element which widens the range of applications for the TMD with regard to excitation frequencies. Typically, these damping elements typically are SCHREIBER visco-elastic dampers which dissipate energy by the movement of a steel cover in a viscous fluid.

TMDs can act in up to three dimensions. SCHREIBER offers TMDs for a broad spectrum of applications. Various designs such as spring or pendulum-type TMDs are used, depending on the specific situation.



## Advantages of Tuned Mass Dampers (TMDs)

- Efficient reduction of structural vibrations
- High savings on overall structural costs
- No external abutment needed
- Suitable both for new and existing structures
- Modular design for application in one to three dimensions

## Configuration of a TMD

The support of engineers is mandatory to ensure proper design of a vibration control solution using SCHREIBER TMDs. The first step in the solution-finding process is a detailed analysis of the vibration problem.

When retrofitting to an existing structure, on-site measurements may be required. The optimum design is defined in close cooperation with the customer.

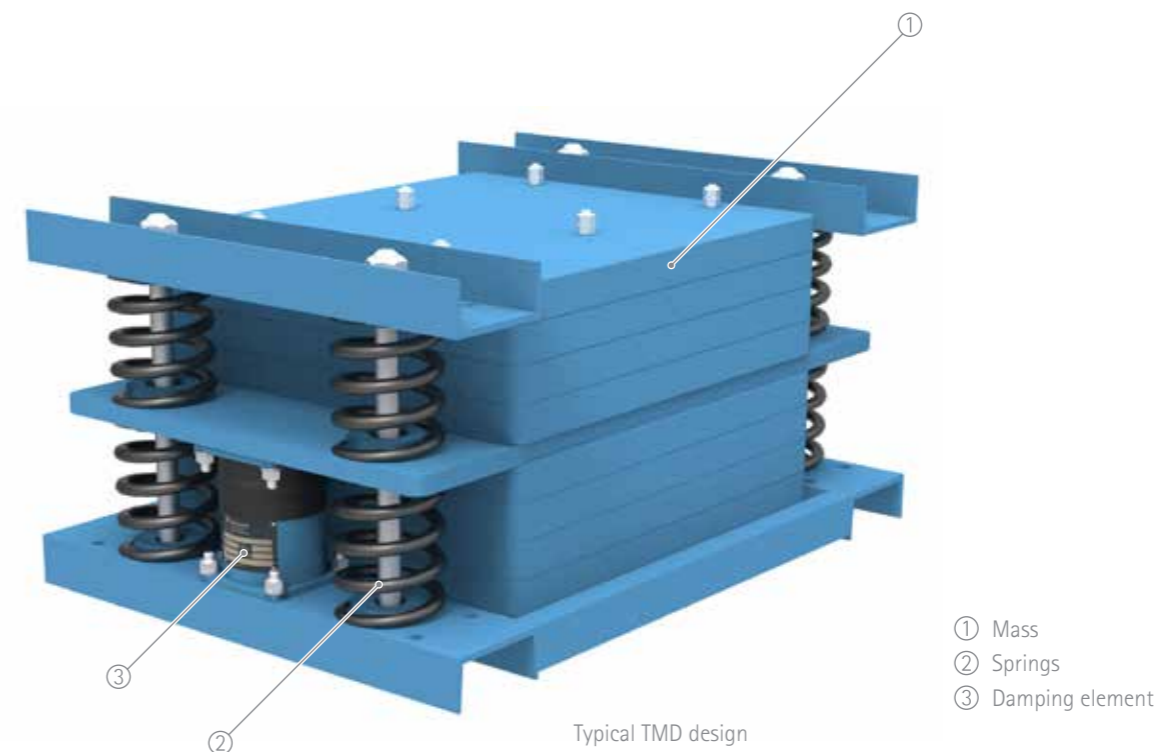

Bahrebachmühle viaduct – Saxony, Germany



Footbridge over the Main – Hesse, Germany



A wide-angle photograph of a large cable-stayed bridge spanning across a body of water. The bridge features a prominent central pylon with two towers, from which numerous stay cables fan out to support the deck. The bridge extends into the distance, where it transitions into a long trestle bridge supported by many smaller piers. The sky is filled with soft, colorful clouds in shades of orange, yellow, and blue, indicating a sunset or sunrise. The water in the foreground is calm, reflecting the bridge and the sky. A vertical line divides the image down the center.

## VISCOUS FLUID DAMPERS

# Seismic devices

In addition to Tuned Mass Dampers, SCHREIBER offers a series of viscous fluid dampers to control unwanted vibrations and counteract shock or pulse loads in bridges. These devices use various physical principles to protect the bridge structure, for example in the case of excitations due to strong winds, earthquakes or traffic. The two basic types of viscous fluid devices are viscous fluid dampers and restraint devices.

## Lock-up devices

Lock-up devices or Shock Transmission Units (STUs) are used to protect bridges against dynamic stresses, in particular due to earthquakes. STUs are normally installed between the roadway and the substructure, i.e. piers and abutments, to control horizontal movements.

STUs operate in two different modes:

- In "standard mode", that is, under normal conditions – in this case, slow movements between the roadway and the substructure in response to thermal expansion, concrete creep and shrinkage are possible with a negligible resistance from the STUs.
- In "safety or lock up mode", that is, under high dynamic excitation – in this case, the STU internally blocks and reacts as a rigid link between the roadway and the substructure so that the exciting forces are completely transferred.

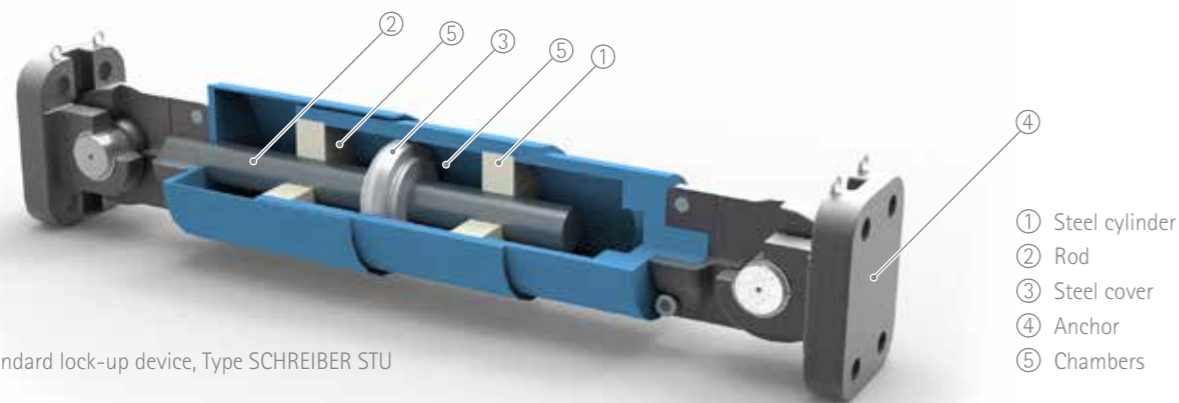

Standard lock-up device, Type SCHREIBER STU

## Design

### Standard design

SCHREIBER standard lock up devices comprise a steel cylinder filled with a special silicone fluid, a rod and a steel cover. The steel cover divides the cylinder into two chambers. With slow movements of the piston, i.e. velocities of less than 0.1 mm/s, the fluid can flow from one chamber to the other through the gap between steel cover and cylinder. In the case of rapid movements, i.e. velocities of more than 1 mm/s, the viscosity of the fluid increases significantly, preventing further flow between the two chambers and thus blocking the internal movement of the device.

### Special design

SCHREIBER also offers special, highly precise blocking devices. LISEGA, SCHREIBER's parent company, is one of the global market leaders for STUs and the preferred supplier for technically demanding STU solutions, for example for application in nuclear power plants. The main difference between standard and special devices is the internal control valve. This valve allows significantly narrower tolerances, which leads to lower friction within the device, i.e. about only 1% of the nominal load instead of 10%. Based on LISEGA's long-standing experience in research into and the development of valves, SCHREIBER is able to customise valves to suit a wide range of special requirements.

A special feature of SCHREIBER STUs is that the valve unit can be replaced without having to remove an installed device. Repeated testing of the valve units is therefore easy and can be carried out with a minimum of effort.

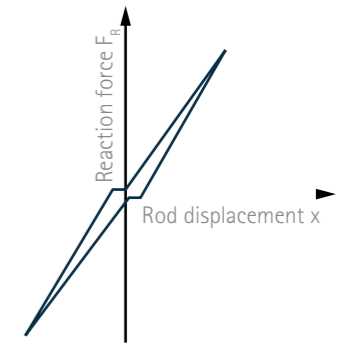

Typical hysteresis of a blocking device during an earthquake



STUs ready for shipping

Type		Behaviour with slow movements (thermal movements, creep, shrinkage)	Behaviour with dynamic loads (vehicle braking, wind, earthquakes)
Lock-up devices (STUs)	» S-STU	Allow movement with negligible reaction force	Transmit dynamic force as a rigid link

## VISCOUS FLUID DAMPERS

# Viscous fluid dampers



Strong winds and earthquakes often subject bridge structures to excessive dynamic loads. In order to ensure that no structural damage occurs, these forces and the resulting displacements need to be reduced to a minimum. Viscous fluid dampers from SCHREIBER reduce these vibrations and pulsed dynamic forces using the technique of energy dissipation.

As viscous fluid dampers reduce the kinetic energy within the structure itself, bridge engineers can use smaller structural elements and less complex structures, thus reducing the overall costs.

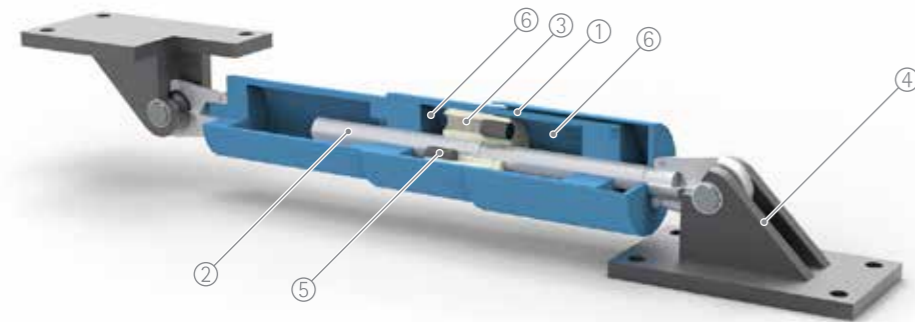

Viscous fluid damper, Type S-VD

### Design

Viscous fluid dampers consist of a hydraulic cylinder, a rod, a steel cover and a valve regulating the flow of the hydraulic fluid from one chamber of the cylinder to the other. The steel cover is equipped with seals to prevent leakage between the chambers and into the environment.

Hydraulic dampers counteract external forces with a reaction force  $F_R$  which can be typically described as follows:

$$F_R = cv^\alpha$$

Typical values for the damping exponent range from 0.01 to 0.4. The graph on page 39 opposite shows the effect of different damping exponents on the resulting reaction force at a given velocity.

The energy dissipated in the damper is a function of the reaction force  $F_R$  and the displacement  $x$ . The size of the elliptical areas in the second graph is proportional to the respective dissipated energy.

Standard valve configurations of viscous fluid dampers typically have very low reaction forces for velocities of less than 0.1 mm/s. Whenever the speed of motion exceeds 1mm/s due to an excitation or vibration, the viscous fluid damper starts to counteract with an increasing reaction force.

Specific force-velocity dependencies can be realised with customised valves, thus creating different dynamic responses of the damper. All valves are configured and tested on our test benches by our engineers.

$F_R$  = reaction force  
 $c$  = damping parameter  
 $v$  = velocity  
 $\alpha$  = damping exponent

- ① Steel cylinder
- ② Rod
- ③ Steel cover
- ④ Anchor
- ⑤ Valve
- ⑥ Chambers

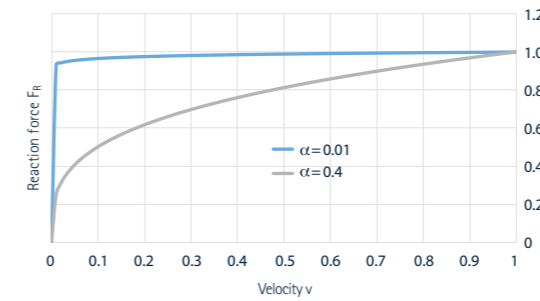

Typical force/velocity diagram for a viscous fluid damper from SCHREIBER

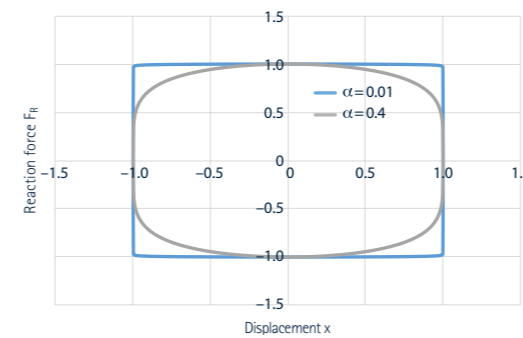

Typical force/velocity diagram



Thyra valley bridge – Saxony-Anhalt, Germany

### Configuration of lock-up devices and viscous fluid dampers

In general, SCHREIBER STUs and viscous fluid dampers are designed in accordance with EN 15129 and provided with a CE Mark. If required, they can also be designed and manufactured in compliance with other international standards or specific customer requirements. The SCHREIBER engineers will help you prepare the specifications in accordance with your requirements.

Type		Behaviour with slow movements (thermal movements, creep, shrinkage)	Behaviour with dynamic loads (vehicle braking, wind, earthquakes)
Viscous fluid dampers	» S-VD	Allow movement with negligible reaction force	Reduce dynamic force by damping energy (by up to 75%)



SCHREIBER is not only a manufacturer of high-quality products, but also a reliable provider of services and solutions. With its extensive experience, SCHREIBER can supplement any product offer with a comprehensive range of technical services, from engineering at the design stage to installation and maintenance or general technical support.

## 1. Structural engineering

SCHREIBER offers the entire scope of structural engineering services for bridges, with a special emphasis on the assessment of dynamic load cases. Structural engineering services can be provided for road, railway, pedestrian and pipe bridges in concrete, steel, composite and lightweight construction:

- Static and dynamic analysis of all load cases including wind loads, seismic loads as well as pedestrian- or traffic-induced loads
- General design support in accordance with German, European or international standards
- Seismic evaluation of existing structures, including the assessment of earthquake damage, with classification of the damage and the development of retrofitting measures
- Definition of measures to reduce unwanted vibrations
- Support during the design of seismic protection equipment



## 2. Vibration measurement

SCHREIBER supports its customers with the extensive experience of highly-specialised measurement engineers. With their comprehensive equipment, SCHREIBER engineers can carry out all relevant vibration measurements, from one-day data acquisition to long-term monitoring including daily or weekly reports.

## 3. Special product design

In addition to its wide range of standard products, SCHREIBER can also develop and manufacture special products in line with exacting technical specifications:

- Extreme loads, strokes or rotations
- Negative loads (lifting devices)
- Special seismic protection devices
- Temporary links or dampers for specific construction phases
- Solutions with minimal space requirements

## 4. Installation

All SCHREIBER products are supplied with comprehensive installation manuals describing the transport, correct handling, installation and commissioning of products in detail. If required, the entire installation can be carried out by a SCHREIBER team or the installation process can take place under supervision by an experienced engineer.

## 5. Repair and maintenance

SCHREIBER engineers can provide the required technical support during all stages of the repair and maintenance of structural bearings, expansion joints, TMDs or viscous fluid devices:

- On-site inspections and structural assessment
- Lifting of bridges, retrofitting or replacement of bearings
- Retrofitting or replacement of expansion joints, viscous fluid devices and dampers
- Seismic evaluation of existing bridges and implementation of seismic protection measures
- Vibration analysis, design and implementation of vibration control solutions

## 6. Monitoring systems

SCHREIBER monitoring solutions are ideal for the remote monitoring of bridges. They can provide detailed information on the status of the products and the overall structures.

For this purpose, sensors are mounted on the structure and connected to a data acquisition unit on site. The data is evaluated and stored by a central computer system. Customers can access the data via web services.

SCHREIBER's bridge monitoring systems have a modular structure. Configuration is carried out individually in accordance with customer requirements.



Special joint before installation



Typical SCHREIBER on-site measuring equipment



# Quality

## 1. Quality

One of the fundamental corporate principles for SCHREIBER is the continuous delivery of premium product quality. This quality culture necessitates close and targeted interaction with the company's business partners and also shapes the organisation and drives the actions of its employees.

The specific measures of the Quality Management department, which ensure product quality, are described in the Quality Management Program. These measures and activities to promote quality are an integral component of the process cycle and are firmly anchored in all procedures.

Based on international codes and standards, the Quality Management Program is described in detail in the Management Manual. This manual takes into account all recognised European and international standards. SCHREIBER is certified to ISO 9001.

## 2. Manufacturing

One of the strengths of SCHREIBER is that not only the design, but almost the entire manufacturing process of the products is carried out in-house. All production phases, from oxyacetylene cutting to machining, drilling, welding, painting and assembly, take place in SCHREIBER'S or LISEGA's own facilities. Thanks to more than 50 years of experience in industrial manufacturing, the LISEGA Group can meet the highest quality standards in delivering high quality products to the power industry and the oil & gas sector.

All steel components are manufactured to EN, DIN, ASTM or CN steel material standards. All welding is carried out in accordance with EN 1090.

## 3. Corrosion protection

SCHREIBER products are designed for a long service life. Depending on customer requirements, various surface protection systems providing corrosion protection in line with the corrosion categories defined in EN ISO 12944 are available.

## 4. Testing

The company's own testing laboratory is equipped to perform static and dynamic tests in axial or multi-dimensional layouts. In addition to standard tests, customer-specific tests can be performed:

- Type testing and final acceptance tests for viscous fluid dampers and Shock Transmission Units (STUs) in accordance with EN 15129
- Final testing of structural bearings in accordance with EN 1337
- Dynamic tests, damping assessment and the tuning of dampers (viscous fluid dampers or Tuned Mass Dampers)
- Fatigue tests on various products (dampers, structural bearings, expansion joints)

## 5. Research and Development

SCHREIBER's wide product range and comprehensive service portfolio allow designers and operators of bridges to solve technical problems related to the structural design, construction and maintenance of bridges. This is the result of SCHREIBER's strong commitment to designing new solutions and improving existing ones.

The SCHREIBER engineers are there to support you. Their aim is always to find the optimum solution.



Dynamic testing of a viscous fluid damper in the SCHREIBER testing laboratory

Quality inspection in the in-house test centre



Test bench in the in-house test centre





**Schreiber  
Brücken-Dehntechnik GmbH**

Am Moosbach 10+12

D-74535 Mainhardt

Tel. +49 (0) 79 03 93 26 - 0

Fax +49 (0) 79 03 93 26 - 26

E-mail [kontakt@schreiber-bruecken.de](mailto:kontakt@schreiber-bruecken.de)

[www.schreiber-bruecken-dehntechnik.de](http://www.schreiber-bruecken-dehntechnik.de)